

Chapter 11

Approximation Algorithms



Slides by Kevin Wayne.
Copyright © 2005 Pearson-Addison Wesley.
All rights reserved.

Approximation Algorithms

Q. Suppose I need to solve an NP-hard problem. What should I do?

A. Theory says you're unlikely to find a poly-time algorithm.

Must sacrifice one of three desired features.

- Solve problem to optimality.
- Solve problem in poly-time.
- Solve arbitrary instances of the problem.

ρ -approximation algorithm.

- Guaranteed to run in poly-time.
- Guaranteed to solve arbitrary instance of the problem
- Guaranteed to find solution within ratio ρ of true optimum.

Challenge. Need to prove a solution's value is close to optimum, without even knowing what optimum value is!

11.1 Load Balancing

Load Balancing

Input. m identical machines; n jobs, job j has processing time t_j .

- Job j must run contiguously on one machine.
- A machine can process at most one job at a time.

Def. Let $J(i)$ be the subset of jobs assigned to machine i . The **load** of machine i is $L_i = \sum_{j \in J(i)} t_j$.

Def. The **makespan** is the maximum load on any machine $L = \max_i L_i$.

Load balancing. Assign each job to a machine to minimize makespan.

Load Balancing: List Scheduling

List-scheduling algorithm.

- Consider n jobs in some fixed order.
- Assign job j to machine whose load is smallest so far.

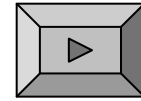

```
List-Scheduling( $m, n, t_1, t_2, \dots, t_n$ ) {  
  for  $i = 1$  to  $m$  {  
     $L_i \leftarrow 0$            ← load on machine  $i$   
     $J(i) \leftarrow \phi$      ← jobs assigned to machine  $i$   
  }  
  
  for  $j = 1$  to  $n$  {  
     $i = \operatorname{argmin}_k L_k$    ← machine  $i$  has smallest load  
     $J(i) \leftarrow J(i) \cup \{j\}$  ← assign job  $j$  to machine  $i$   
     $L_i \leftarrow L_i + t_j$  ← update load of machine  $i$   
  }  
}
```

Implementation. $O(n \log m)$ using a priority queue.

Load Balancing: List Scheduling Analysis

Theorem. [Graham, 1966] Greedy algorithm is a 2-approximation.

- First worst-case analysis of an approximation algorithm.
- Need to compare resulting solution with optimal makespan L^* .

Lemma 1. The optimal makespan $L^* \geq \max_j t_j$.

Pf. Some machine must process the most time-consuming job. ■

Lemma 2. The optimal makespan $L^* \geq \frac{1}{m} \sum_j t_j$.

Pf.

- The total processing time is $\sum_j t_j$.
- One of m machines must do at least a $1/m$ fraction of total work. ■

Load Balancing: List Scheduling Analysis

Theorem. Greedy algorithm is a 2-approximation.

Pf. Consider load L_i of bottleneck machine i .

- Let j be last job scheduled on machine i .
- When job j assigned to machine i , i had smallest load. Its load before assignment is $L_i - t_j \Rightarrow L_i - t_j \leq L_k$ for all $1 \leq k \leq m$.

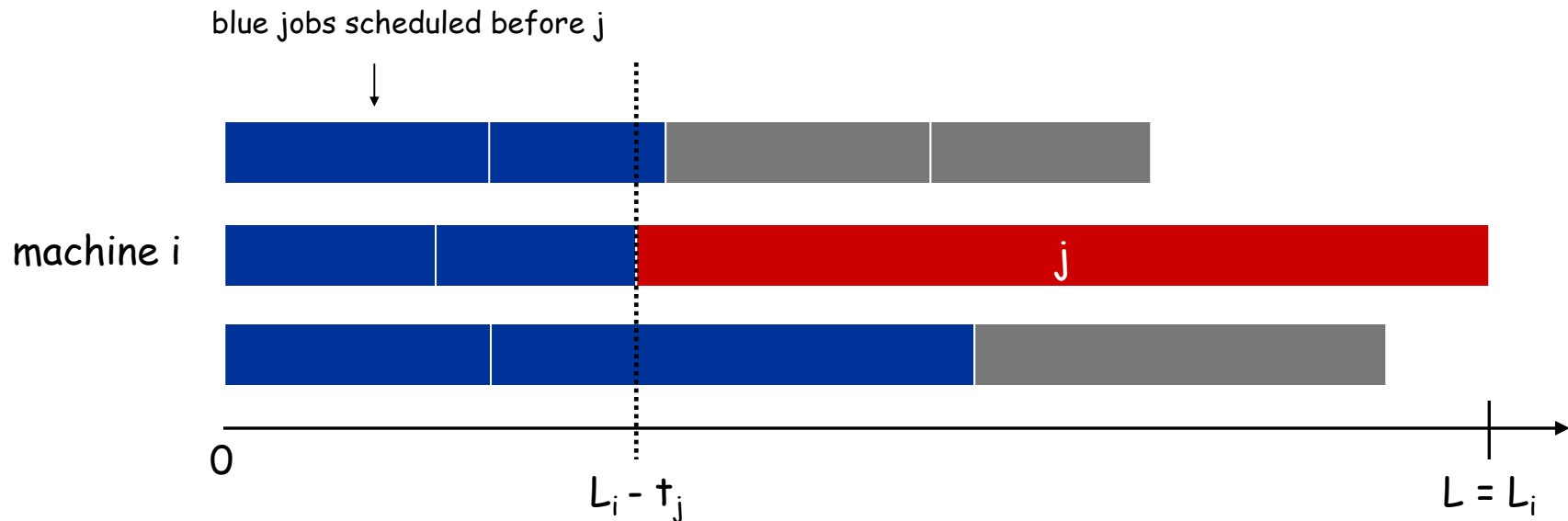

Load Balancing: List Scheduling Analysis

Theorem. Greedy algorithm is a 2-approximation.

Pf. Consider load L_i of bottleneck machine i .

- Let j be last job scheduled on machine i .
- When job j assigned to machine i , i had smallest load. Its load before assignment is $L_i - t_j \Rightarrow L_i - t_j \leq L_k$ for all $1 \leq k \leq m$.
- Sum inequalities over all k and divide by m :

$$\begin{aligned} L_i - t_j &\leq \frac{1}{m} \sum_k L_k \\ &= \frac{1}{m} \sum_k t_k \\ \text{Lemma 1} \rightarrow &\leq L^* \end{aligned}$$

▪ Now $L_i = \underbrace{(L_i - t_j)}_{\leq L^*} + \underbrace{t_j}_{\leq L^*} \leq 2L^*.$ ▪

↑
Lemma 2

Load Balancing: List Scheduling Analysis

Q. Is our analysis tight?

A. Essentially yes.

Ex: m machines, $m(m-1)$ jobs length 1 jobs, one job of length m

$m = 10$

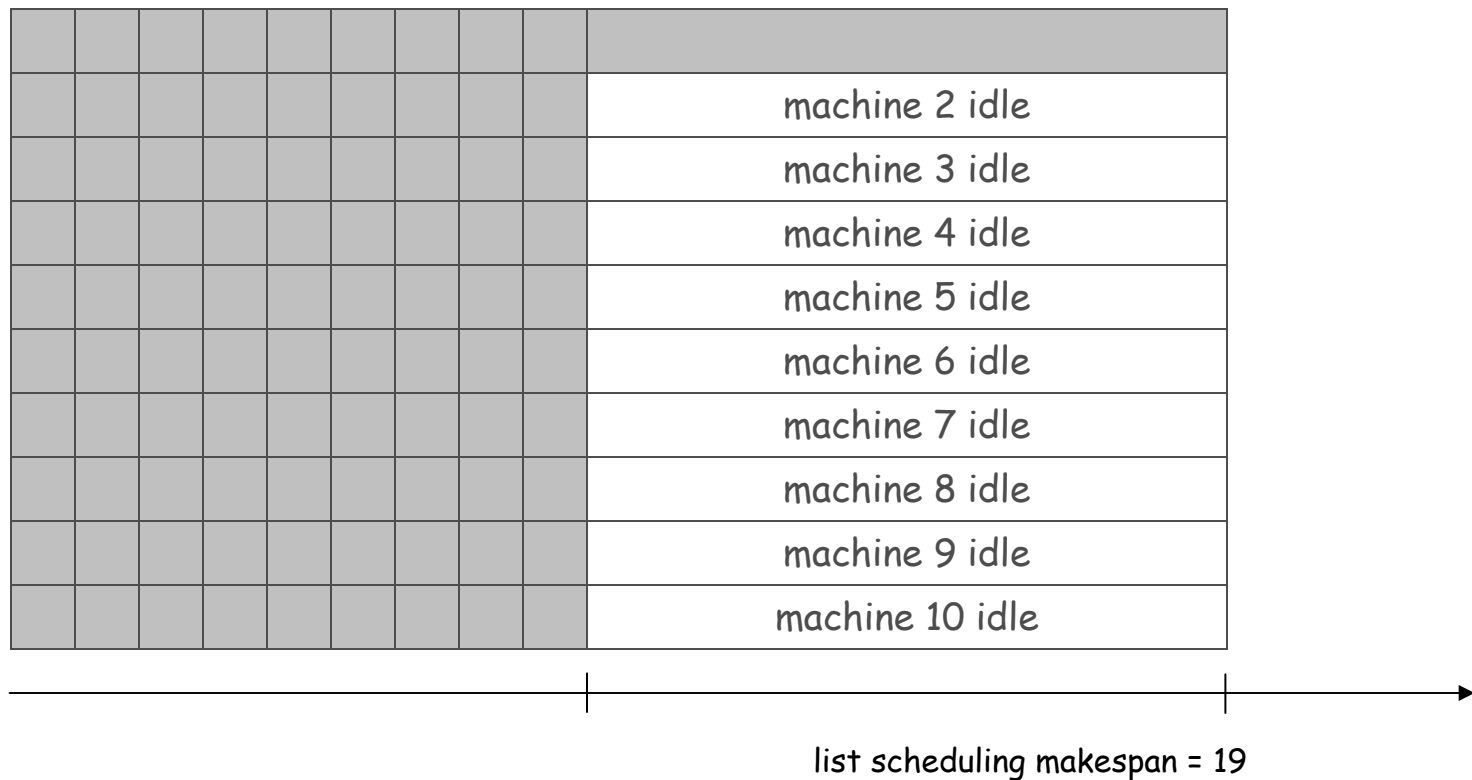

Load Balancing: List Scheduling Analysis

Q. Is our analysis tight?

A. Essentially yes.

Ex: m machines, $m(m-1)$ jobs length 1 jobs, one job of length m

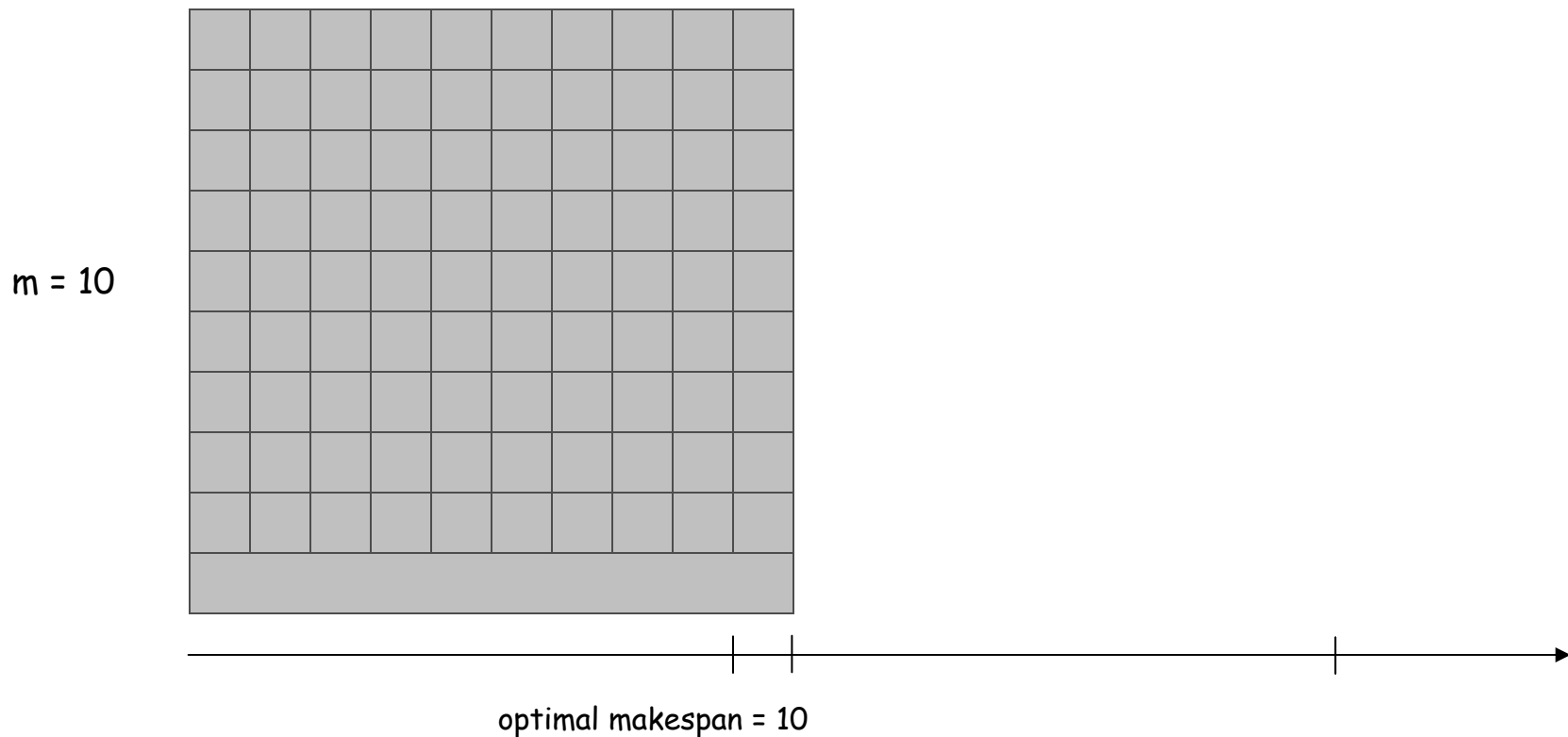

Load Balancing: LPT Rule

Longest processing time (LPT). Sort n jobs in descending order of processing time, and then run list scheduling algorithm.

```
LPT-List-Scheduling( $m, n, t_1, t_2, \dots, t_n$ ) {  
  Sort jobs so that  $t_1 \geq t_2 \geq \dots \geq t_n$   
  
  for  $i = 1$  to  $m$  {  
     $L_i \leftarrow 0$            ← load on machine  $i$   
     $J(i) \leftarrow \phi$      ← jobs assigned to machine  $i$   
  }  
  
  for  $j = 1$  to  $n$  {  
     $i = \operatorname{argmin}_k L_k$    ← machine  $i$  has smallest load  
     $J(i) \leftarrow J(i) \cup \{j\}$  ← assign job  $j$  to machine  $i$   
     $L_i \leftarrow L_i + t_j$  ← update load of machine  $i$   
  }  
}
```

Load Balancing: LPT Rule

Observation. If at most m jobs, then list-scheduling is optimal.

Pf. Each job put on its own machine. ■

Lemma 3. If there are more than m jobs, $L^* \geq 2 t_{m+1}$.

Pf.

- Consider first $m+1$ jobs t_1, \dots, t_{m+1} .
- Since the t_i 's are in descending order, each takes at least t_{m+1} time.
- There are $m+1$ jobs and m machines, so by pigeonhole principle, at least one machine gets two jobs. ■

Theorem. LPT rule is a $3/2$ approximation algorithm.

Pf. Same basic approach as for list scheduling.

$$L_i = \underbrace{(L_i - t_j)}_{\leq L^*} + \underbrace{t_j}_{\leq \frac{1}{2}L^*} \leq \frac{3}{2}L^*. \quad \blacksquare$$

Lemma 3

(by observation, can assume number of jobs $> m$)

Load Balancing: LPT Rule

Q. Is our $3/2$ analysis tight?

A. No.

Theorem. [Graham, 1969] LPT rule is a $4/3$ -approximation.

Pf. More sophisticated analysis of same algorithm.

Q. Is Graham's $4/3$ analysis tight?

A. Essentially yes.

Ex: m machines, $n = 2m+1$ jobs, 2 jobs of length $m+1, m+2, \dots, 2m-1$ and one job of length m .

11.2 Center Selection

Center Selection Problem

Input. Set of n sites s_1, \dots, s_n .

Center selection problem. Select k centers C so that maximum distance from a site to nearest center is minimized.

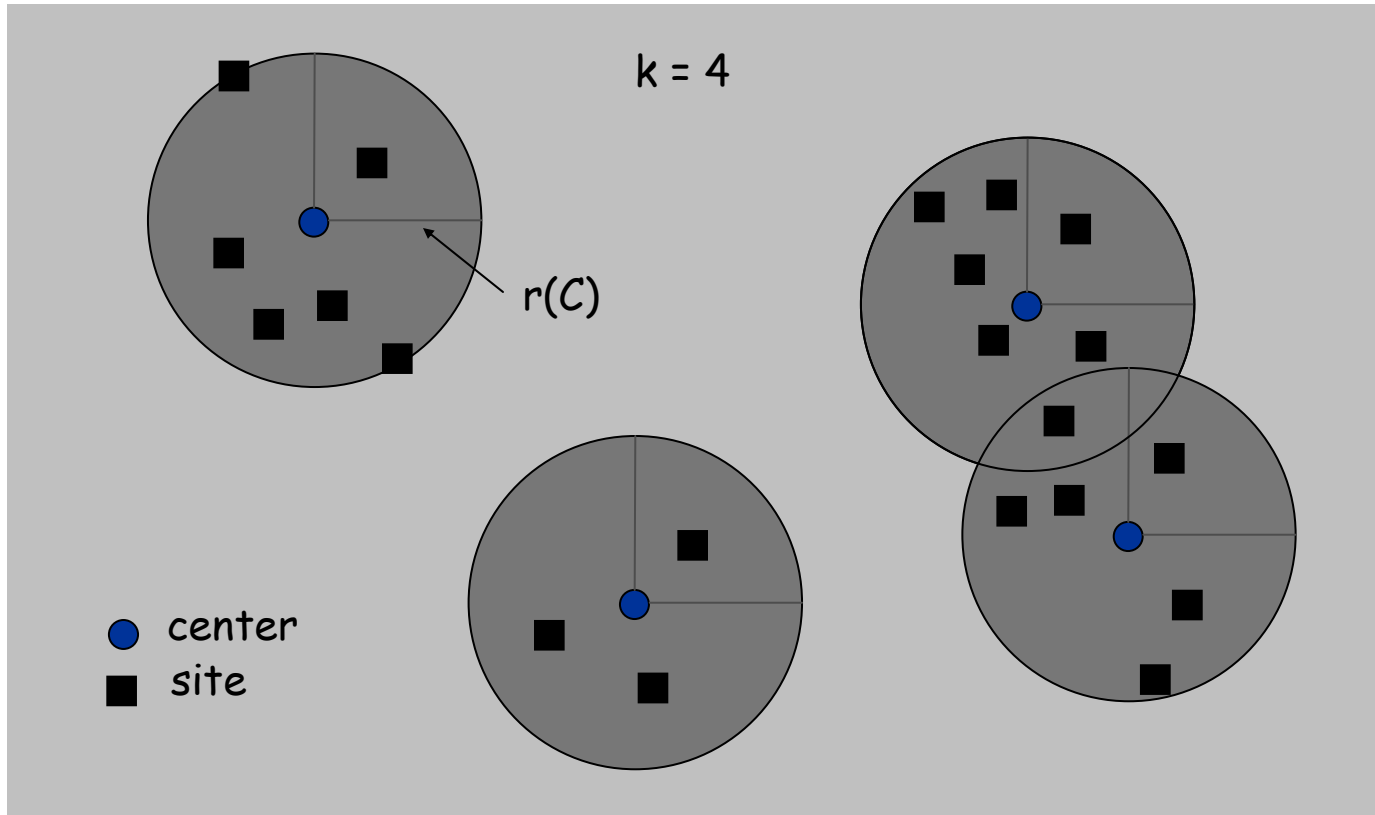

Center Selection Problem

Input. Set of n sites s_1, \dots, s_n .

Center selection problem. Select k centers C so that maximum distance from a site to nearest center is minimized.

Notation.

- $\text{dist}(x, y)$ = distance between x and y .
- $\text{dist}(s_i, C) = \min_{c \in C} \text{dist}(s_i, c)$ = distance from s_i to closest center.
- $r(C) = \max_i \text{dist}(s_i, C)$ = smallest covering radius.

Goal. Find set of centers C that minimizes $r(C)$, subject to $|C| = k$.

Distance function properties.

- $\text{dist}(x, x) = 0$ (identity)
- $\text{dist}(x, y) = \text{dist}(y, x)$ (symmetry)
- $\text{dist}(x, y) \leq \text{dist}(x, z) + \text{dist}(z, y)$ (triangle inequality)

Center Selection Example

Ex: each site is a point in the plane, a center can be any point in the plane, $\text{dist}(x, y) = \text{Euclidean distance}$.

Remark: search can be infinite!

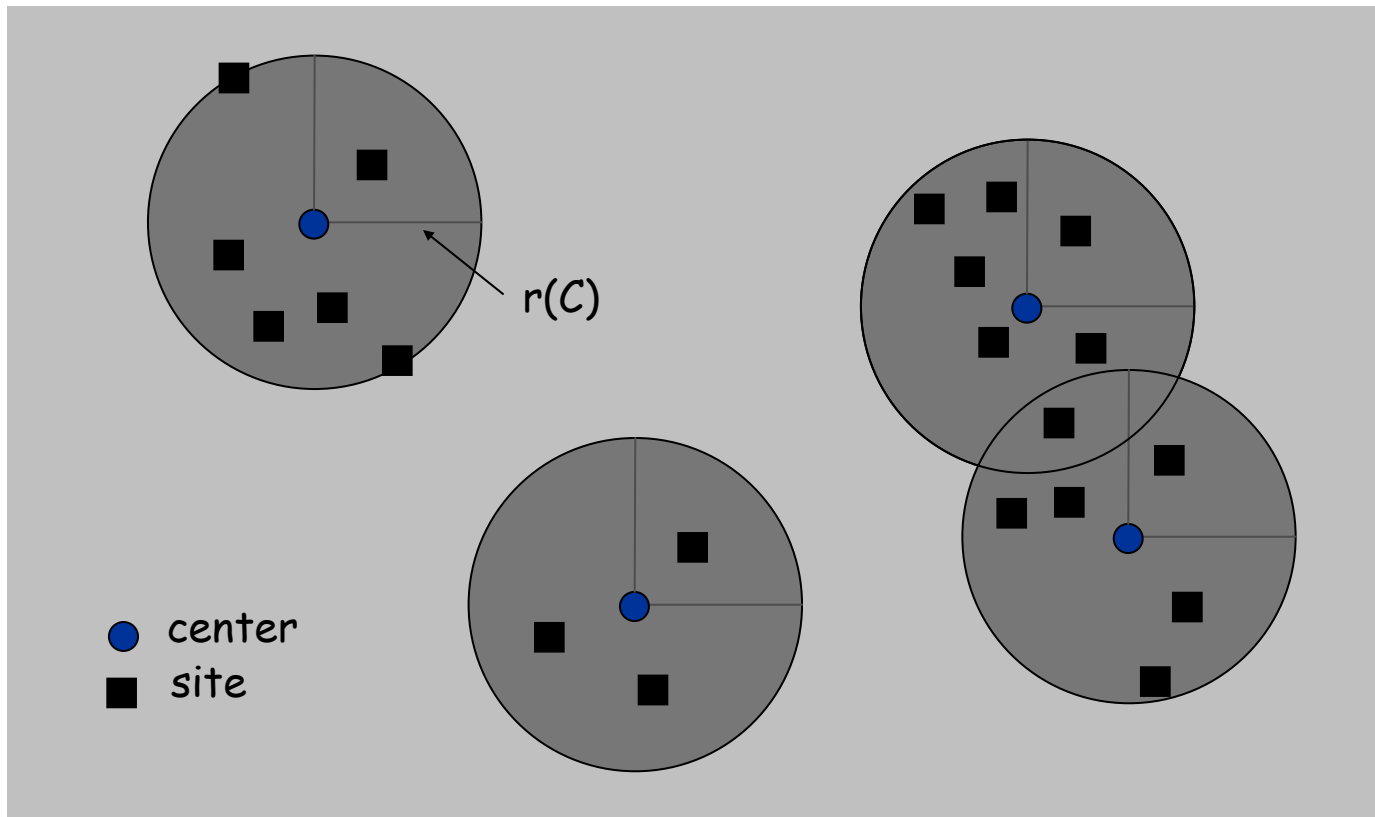

Greedy Algorithm: A False Start

Greedy algorithm. Put the first center at the best possible location for a single center, and then keep adding centers so as to reduce the covering radius each time by as much as possible.

Remark: arbitrarily bad!

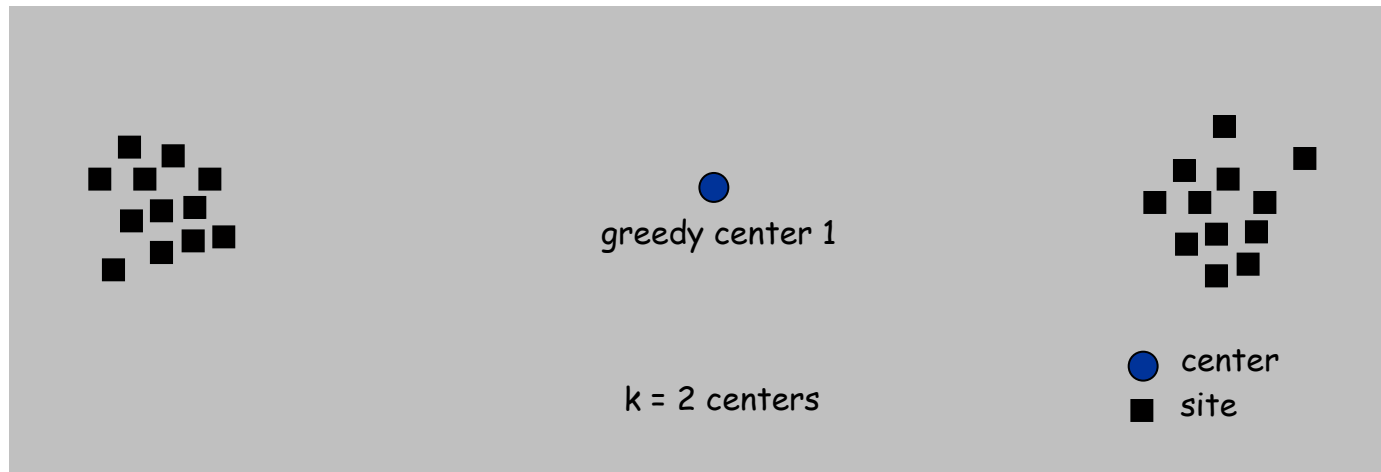

Center Selection: Greedy Algorithm

Greedy algorithm. Repeatedly choose the next center to be the site **farthest** from any existing center.

```
Greedy-Center-Selection(k, n, s1, s2, ..., sn) {  
  
    C =  $\phi$   
    repeat k times {  
        Select a site si with maximum dist(si, C)  
        Add si to C  
    }  
    return C  
}
```

↑
site farthest from any center

Observation. Upon termination all centers in C are pairwise at least $r(C)$ apart.

Pf. By construction of algorithm.

Center Selection: Analysis of Greedy Algorithm

Theorem. Let C^* be an optimal set of centers. Then $r(C) \leq 2r(C^*)$.

Pf. (by contradiction) Assume $r(C^*) < \frac{1}{2} r(C)$.

- For each site c_i in C , consider ball of radius $\frac{1}{2} r(C)$ around it.
- Exactly one c_i^* in each ball; let c_i be the site paired with c_i^* .
- Consider any site s and its closest center c_i^* in C^* .
- $\text{dist}(s, C) \leq \text{dist}(s, c_i) \leq \text{dist}(s, c_i^*) + \text{dist}(c_i^*, c_i) \leq 2r(C^*)$.
- Thus $r(C) \leq 2r(C^*)$. \triangleleft -inequality $\leq r(C^*)$ since c_i^* is closest center

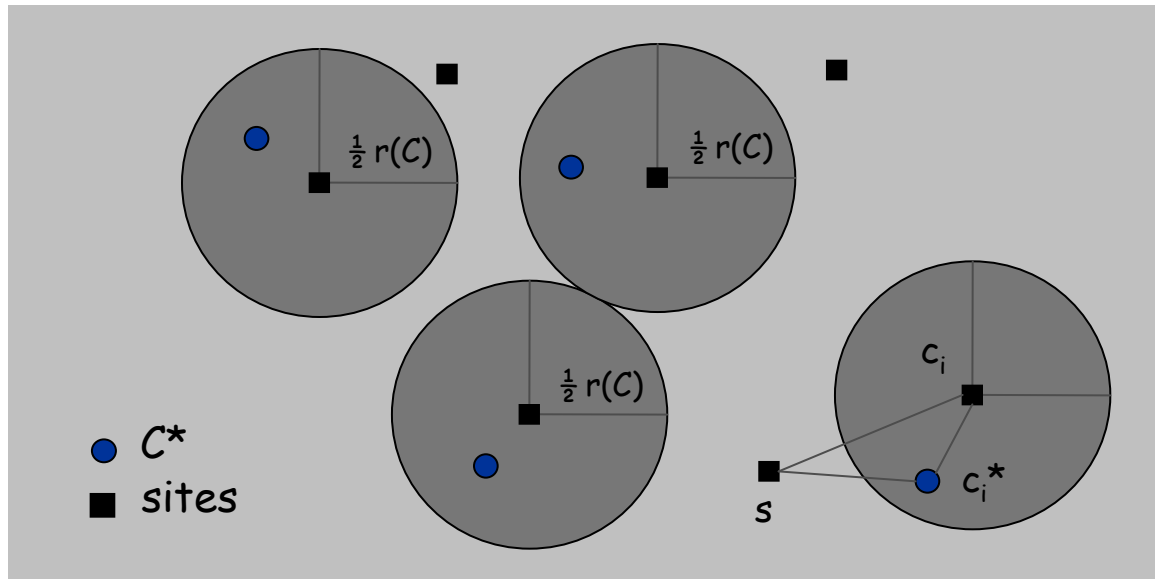

Center Selection

Theorem. Let C^* be an optimal set of centers. Then $r(C) \leq 2r(C^*)$.

Theorem. Greedy algorithm is a 2-approximation for center selection problem.

Remark. Greedy algorithm always places centers at sites, but is still within a factor of 2 of best solution that is allowed to place centers anywhere.

 e.g., points in the plane

Question. Is there hope of a $3/2$ -approximation? $4/3$?

Theorem. Unless $P = NP$, there no ρ -approximation for center-selection problem for any $\rho < 2$.

11.4 The Pricing Method: Vertex Cover

Weighted Vertex Cover

Weighted vertex cover. Given a graph G with vertex weights, find a vertex cover of minimum weight.

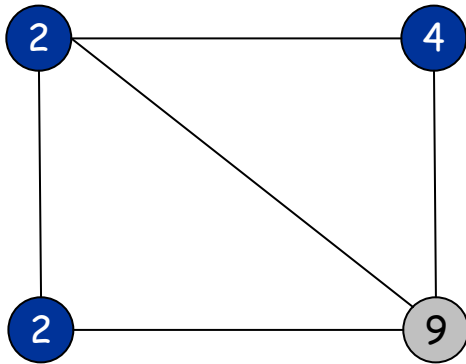

$$\text{weight} = 2 + 2 + 4$$

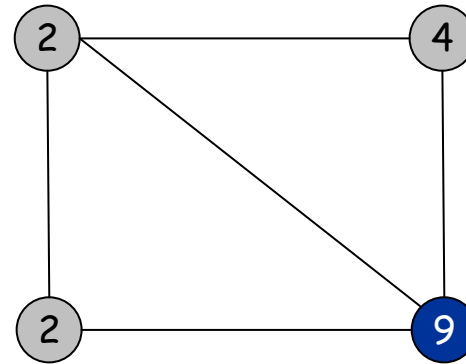

$$\text{weight} = 9$$

Weighted Vertex Cover

Pricing method. Each edge must be covered by some vertex i . Edge e pays price $p_e \geq 0$ to use vertex i .

Fairness. Edges incident to vertex i should pay $\leq w_i$ in total.

$$\text{for each vertex } i: \sum_{e=(i,j)} p_e \leq w_i$$

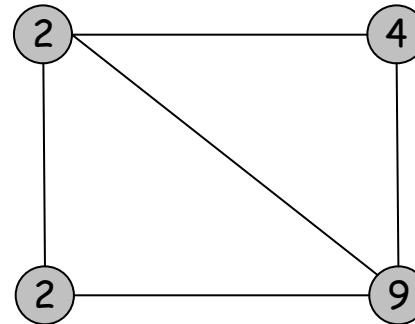

Claim. For any vertex cover S and any fair prices p_e : $\sum_e p_e \leq w(S)$.

Proof.

$$\sum_{e \in E} p_e \leq \sum_{i \in S} \sum_{e=(i,j)} p_e \leq \sum_{i \in S} w_i = w(S).$$

↑
each edge e covered by
at least one node in S

↑
sum fairness inequalities
for each node in S

Pricing Method

Pricing method. Set prices and find vertex cover simultaneously.

```
Weighted-Vertex-Cover-Approx(G, w) {  
  foreach e in E  
    pe = 0  
  
  while (∃ edge i-j such that neither i nor j are tight)  
    select such an edge e  
    increase pe without violating fairness  
}  
  
S ← set of all tight nodes  
return S  
}
```

$$\sum_{e=(i,j)} p_e = w_i$$

↓

Pricing Method

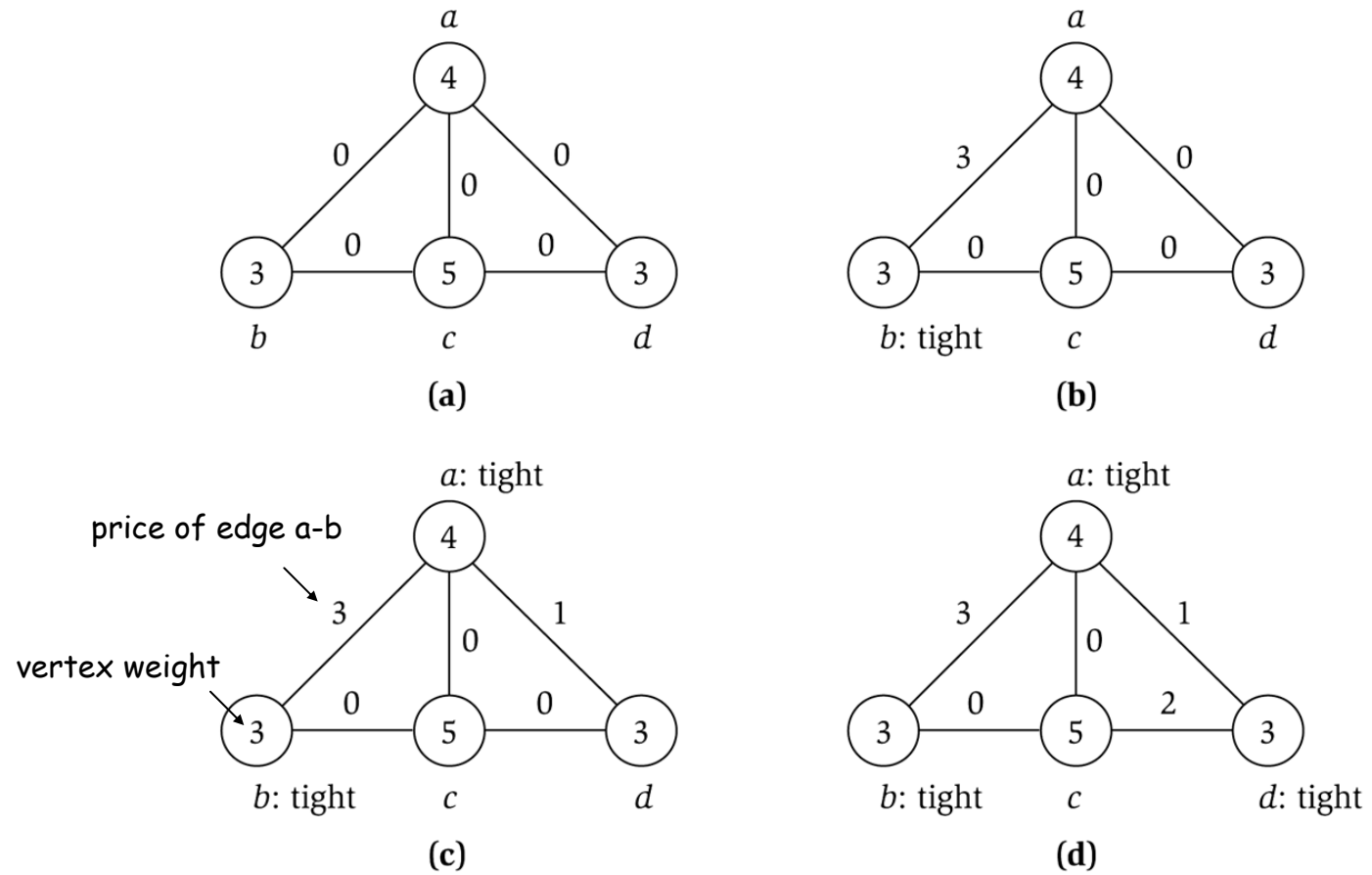

Figure 11.8

Pricing Method: Analysis

Theorem. Pricing method is a 2-approximation.

Pf.

- Algorithm terminates since at least one new node becomes tight after each iteration of while loop.
- Let S = set of all tight nodes upon termination of algorithm. S is a vertex cover: if some edge i - j is uncovered, then neither i nor j is tight. But then while loop would not terminate.
- Let S^* be optimal vertex cover. We show $w(S) \leq 2w(S^*)$.

$$w(S) = \sum_{i \in S} w_i = \sum_{i \in S} \sum_{e=(i,j)} p_e \leq \sum_{i \in V} \sum_{e=(i,j)} p_e = 2 \sum_{e \in E} p_e \leq 2w(S^*). \quad \blacksquare$$

\uparrow all nodes in S are tight \uparrow $S \subseteq V$, prices ≥ 0 \uparrow each edge counted twice \uparrow fairness lemma

11.6 LP Rounding: Vertex Cover

Weighted Vertex Cover

Weighted vertex cover. Given an undirected graph $G = (V, E)$ with vertex weights $w_i \geq 0$, find a minimum weight subset of nodes S such that every edge is incident to at least one vertex in S .

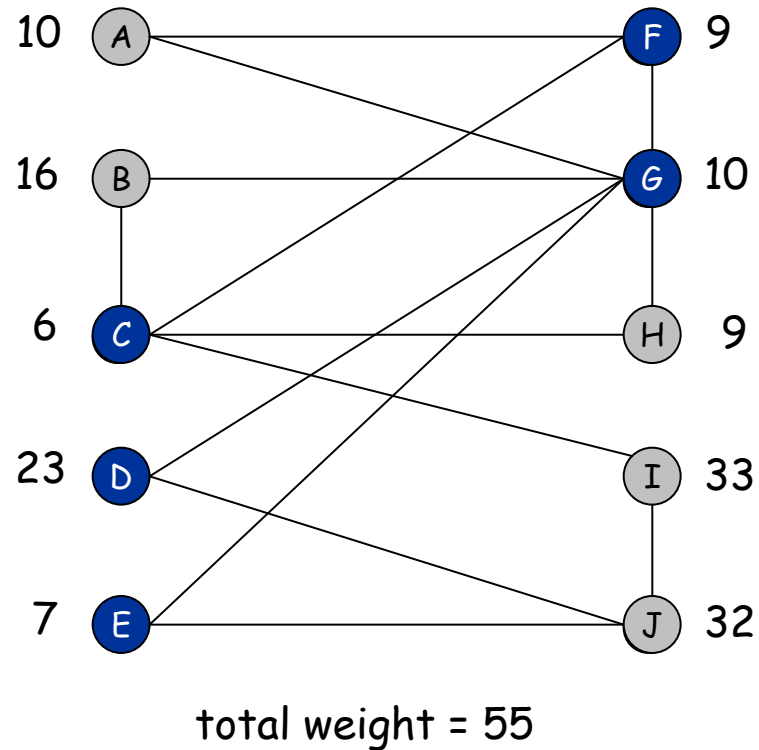

Weighted Vertex Cover: IP Formulation

Weighted vertex cover. Given an undirected graph $G = (V, E)$ with vertex weights $w_i \geq 0$, find a minimum weight subset of nodes S such that every edge is incident to at least one vertex in S .

Integer programming formulation.

- Model inclusion of each vertex i using a 0/1 variable x_i .

$$x_i = \begin{cases} 0 & \text{if vertex } i \text{ is not in vertex cover} \\ 1 & \text{if vertex } i \text{ is in vertex cover} \end{cases}$$

Vertex covers in 1-1 correspondence with 0/1 assignments:

$$S = \{i \in V : x_i = 1\}$$

- Objective function: maximize $\sum_i w_i x_i$.
- Must take either i or j : $x_i + x_j \geq 1$.

Weighted Vertex Cover: IP Formulation

Weighted vertex cover. Integer programming formulation.

$$\begin{aligned} (ILP) \quad & \min \quad \sum_{i \in V} w_i x_i \\ & \text{s. t.} \quad x_i + x_j \geq 1 \quad (i, j) \in E \\ & \quad \quad x_i \in \{0, 1\} \quad i \in V \end{aligned}$$

Observation. If x^* is optimal solution to (ILP), then $S = \{i \in V : x_i^* = 1\}$ is a min weight vertex cover.

Integer Programming

INTEGER-PROGRAMMING. Given integers a_{ij} and b_i , find integers x_j that satisfy:

$$\begin{array}{ll} \max & c^t x \\ \text{s. t.} & Ax \geq b \\ & x \text{ integral} \end{array}$$

$$\begin{array}{lll} \sum_{j=1}^n a_{ij} x_j & \geq & b_i \quad 1 \leq i \leq m \\ x_j & \geq & 0 \quad 1 \leq j \leq n \\ x_j & \text{integral} & 1 \leq j \leq n \end{array}$$

Observation. Vertex cover formulation proves that integer programming is NP-hard search problem.

↖
even if all coefficients are 0/1 and
at most two variables per inequality

Linear Programming

Linear programming. Max/min linear objective function subject to linear inequalities.

- Input: integers c_j, b_i, a_{ij} .
- Output: **real numbers** x_j .

$$\begin{aligned} \text{(P)} \quad & \max \quad c^t x \\ & \text{s. t.} \quad Ax \geq b \\ & \quad \quad x \geq 0 \end{aligned}$$

$$\begin{aligned} \text{(P)} \quad & \max \quad \sum_{j=1}^n c_j x_j \\ & \text{s. t.} \quad \sum_{j=1}^n a_{ij} x_j \geq b_i \quad 1 \leq i \leq m \\ & \quad \quad x_j \geq 0 \quad 1 \leq j \leq n \end{aligned}$$

Linear. No x^2 , xy , $\arccos(x)$, $x(1-x)$, etc.

Simplex algorithm. [Dantzig 1947] Can solve LP in practice.

Ellipsoid algorithm. [Khachian 1979] Can solve LP in poly-time.

LP Feasible Region

LP geometry in 2D.

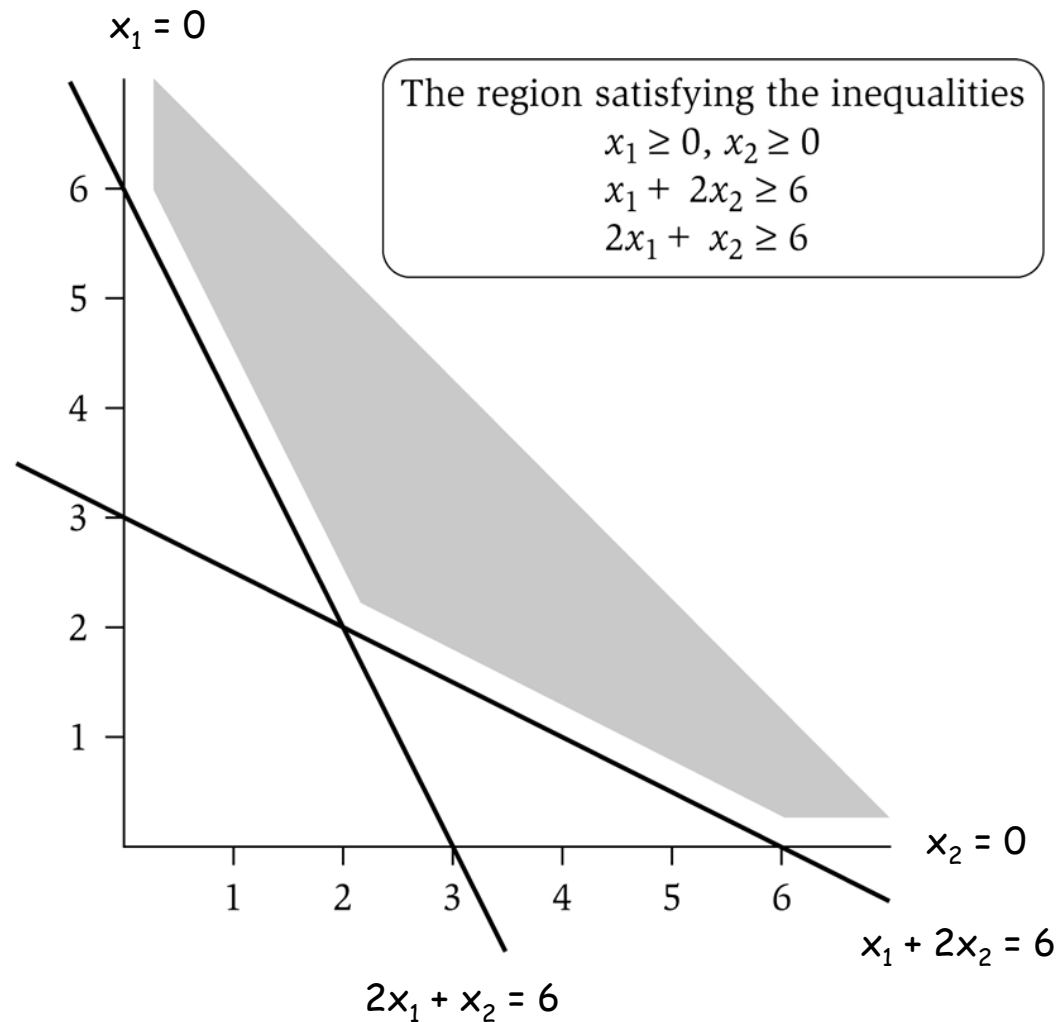

Weighted Vertex Cover: LP Relaxation

Weighted vertex cover. Linear programming formulation.

$$\begin{aligned} (LP) \quad \min \quad & \sum_{i \in V} w_i x_i \\ \text{s. t.} \quad & x_i + x_j \geq 1 \quad (i, j) \in E \\ & x_i \geq 0 \quad i \in V \end{aligned}$$

Observation. Optimal value of (LP) is \leq optimal value of (ILP).

Pf. LP has fewer constraints.

Note. LP is not equivalent to vertex cover.

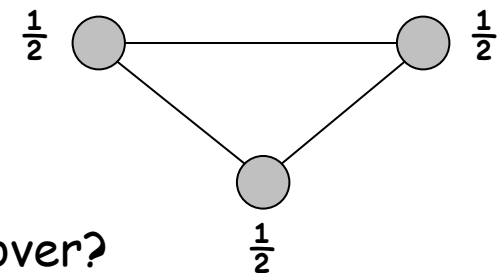

Q. How can solving LP help us find a small vertex cover?

A. Solve LP and **round** fractional values.

Weighted Vertex Cover

Theorem. If x^* is optimal solution to (LP), then $S = \{i \in V : x_i^* \geq \frac{1}{2}\}$ is a vertex cover whose weight is at most twice the min possible weight.

Pf. [S is a vertex cover]

- Consider an edge $(i, j) \in E$.
- Since $x_i^* + x_j^* \geq 1$, either $x_i^* \geq \frac{1}{2}$ or $x_j^* \geq \frac{1}{2} \Rightarrow (i, j)$ covered.

Pf. [S has desired cost]

- Let S^* be optimal vertex cover. Then

$$\begin{array}{ccccc} \sum_{i \in S^*} w_i & \geq & \sum_{i \in S} w_i x_i^* & \geq & \frac{1}{2} \sum_{i \in S} w_i \\ & \uparrow & & \uparrow & \\ & \text{LP is a relaxation} & & x_i^* \geq \frac{1}{2} & \end{array}$$

Weighted Vertex Cover

Theorem. 2-approximation algorithm for weighted vertex cover.

Theorem. [Dinur-Safra 2001] If $P \neq NP$, then no ρ -approximation for $\rho < 1.3607$, even with unit weights.

↖
 $10\sqrt{5} - 21$

Open research problem. Close the gap.

* 11.7 Load Balancing Reloaded

Generalized Load Balancing

Input. Set of m machines M ; set of n jobs J .

- Job j must run contiguously on an **authorized machine** in $M_j \subseteq M$.
- Job j has processing time t_j .
- Each machine can process at most one job at a time.

Def. Let $J(i)$ be the subset of jobs assigned to machine i . The load of machine i is $L_i = \sum_{j \in J(i)} t_j$.

Def. The makespan is the maximum load on any machine = $\max_i L_i$.

Generalized load balancing. Assign each job to an authorized machine to minimize makespan.

Generalized Load Balancing: Integer Linear Program and Relaxation

ILP formulation. x_{ij} = time machine i spends processing job j .

$$\begin{aligned} (IP) \quad & \min \quad L \\ & \text{s. t.} \quad \sum_i x_{ij} = t_j \quad \text{for all } j \in J \\ & \quad \quad \sum_j x_{ij} \leq L \quad \text{for all } i \in M \\ & \quad \quad x_{ij} \in \{0, t_j\} \quad \text{for all } j \in J \text{ and } i \in M_j \\ & \quad \quad x_{ij} = 0 \quad \text{for all } j \in J \text{ and } i \notin M_j \end{aligned}$$

LP relaxation.

$$\begin{aligned} (LP) \quad & \min \quad L \\ & \text{s. t.} \quad \sum_i x_{ij} = t_j \quad \text{for all } j \in J \\ & \quad \quad \sum_j x_{ij} \leq L \quad \text{for all } i \in M \\ & \quad \quad x_{ij} \geq 0 \quad \text{for all } j \in J \text{ and } i \in M_j \\ & \quad \quad x_{ij} = 0 \quad \text{for all } j \in J \text{ and } i \notin M_j \end{aligned}$$

Generalized Load Balancing: Lower Bounds

Lemma 1. Let L be the optimal value to the LP. Then, the optimal makespan $L^* \geq L$.

Pf. LP has fewer constraints than IP formulation.

Lemma 2. The optimal makespan $L^* \geq \max_j t_j$.

Pf. Some machine must process the most time-consuming job. ■

Generalized Load Balancing: Structure of LP Solution

Lemma 3. Let x be solution to LP. Let $G(x)$ be the graph with an edge from machine i to job j if $x_{ij} > 0$. Then $G(x)$ is **acyclic**.

Pf. (deferred)

↑
can transform x into another LP solution where $G(x)$ is acyclic if LP solver doesn't return such an x

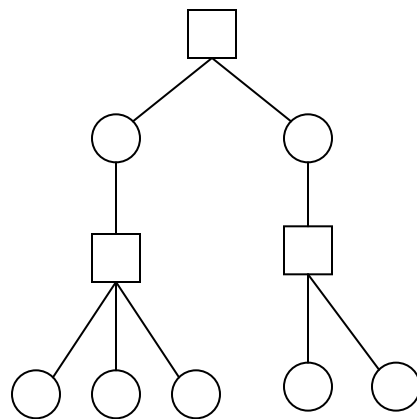

$G(x)$ acyclic

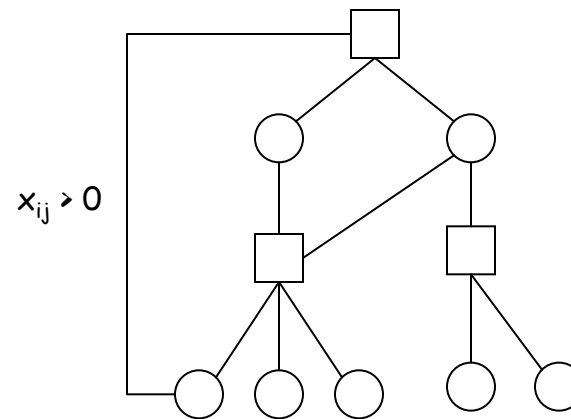

$G(x)$ cyclic

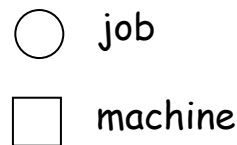

Generalized Load Balancing: Rounding

Rounded solution. Find LP solution x where $G(x)$ is a forest. Root forest $G(x)$ at some arbitrary machine node r .

- If job j is a leaf node, assign j to its parent machine i .
- If job j is not a leaf node, assign j to one of its children.

Lemma 4. Rounded solution only assigns jobs to authorized machines.

Pf. If job j is assigned to machine i , then $x_{ij} > 0$. LP solution can only assign positive value to authorized machines. ▪

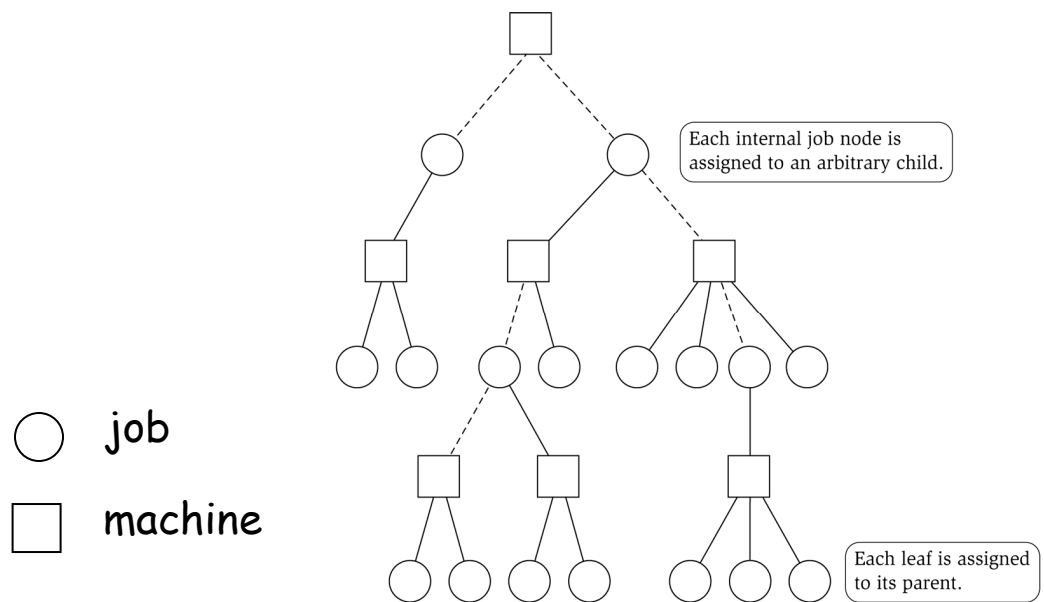

Generalized Load Balancing: Analysis

Lemma 5. If job j is a leaf node and machine $i = \text{parent}(j)$, then $x_{ij} = t_j$.

Pf. Since i is a leaf, $x_{ij} = 0$ for all $j \neq \text{parent}(i)$. LP constraint guarantees $\sum_i x_{ij} = t_j$. ■

Lemma 6. At most one non-leaf job is assigned to a machine.

Pf. The only possible non-leaf job assigned to machine i is $\text{parent}(i)$. ■

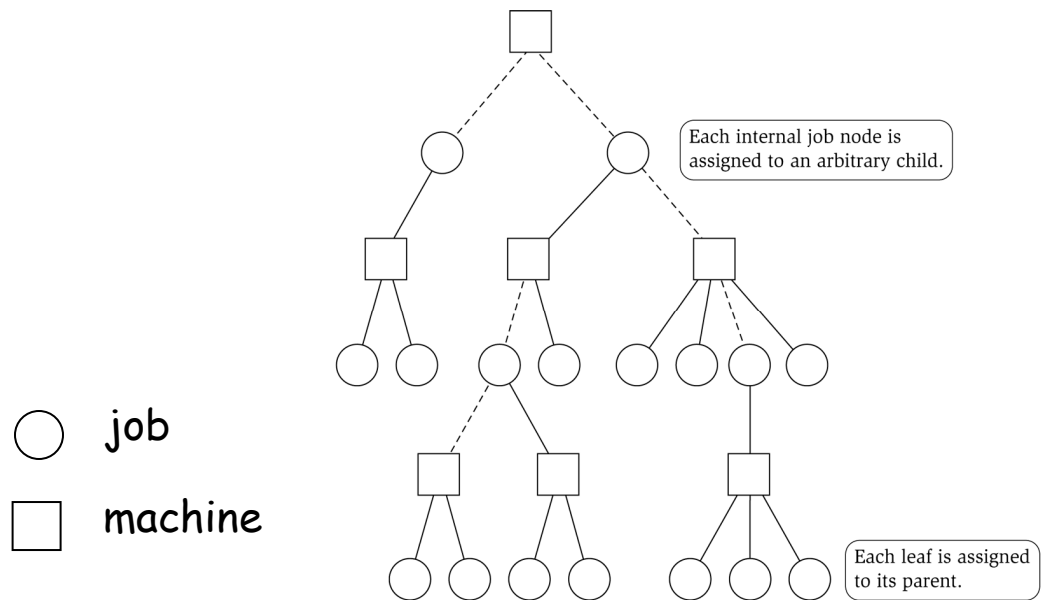

Generalized Load Balancing: Analysis

Theorem. Rounded solution is a 2-approximation.

Pf.

- Let $J(i)$ be the jobs assigned to machine i .
- By Lemma 6, the load L_i on machine i has two components:

- leaf nodes

$$\begin{array}{c}
 \text{Lemma 5} \\
 \downarrow \\
 \sum_{\substack{j \in J(i) \\ j \text{ is a leaf}}} t_j = \sum_{\substack{j \in J(i) \\ j \text{ is a leaf}}} x_{ij} \leq \sum_{j \in J} x_{ij} \leq L \leq L^* \\
 \begin{array}{c}
 \text{LP} \quad \text{Lemma 1 (LP is a relaxation)} \\
 \downarrow \quad \downarrow \\
 \uparrow \\
 \text{optimal value of LP}
 \end{array}
 \end{array}$$

- parent(i)

$$\begin{array}{c}
 \text{Lemma 2} \\
 \downarrow \\
 t_{\text{parent}(i)} \leq L^*
 \end{array}$$

- Thus, the overall load $L_i \leq 2L^*$. ■

Generalized Load Balancing: Flow Formulation

Flow formulation of LP.

$$\begin{aligned} \sum_i x_{ij} &= t_j \quad \text{for all } j \in J \\ \sum_j x_{ij} &\leq L \quad \text{for all } i \in M \\ x_{ij} &\geq 0 \quad \text{for all } j \in J \text{ and } i \in M_j \\ x_{ij} &= 0 \quad \text{for all } j \in J \text{ and } i \notin M_j \end{aligned}$$

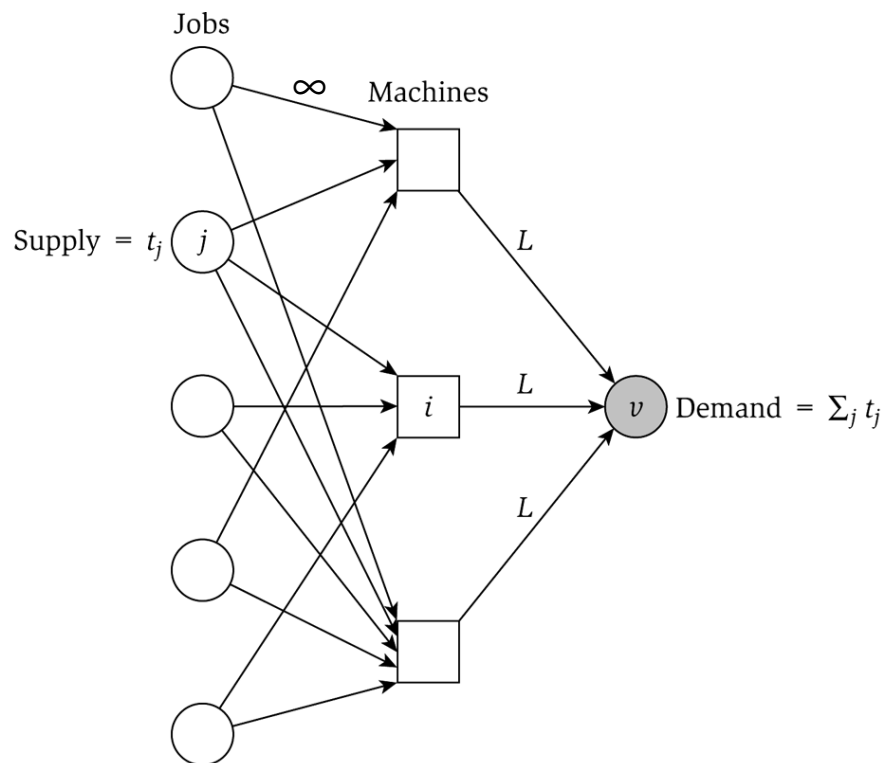

Observation. Solution to feasible flow problem with value L are in one-to-one correspondence with LP solutions of value L .

Generalized Load Balancing: Structure of Solution

Lemma 3. Let (x, L) be solution to LP. Let $G(x)$ be the graph with an edge from machine i to job j if $x_{ij} > 0$. We can find another solution (x', L) such that $G(x')$ is acyclic.

Pf. Let C be a cycle in $G(x)$.

- Augment flow along the cycle C . ← flow conservation maintained
- At least one edge from C is removed (and none are added).
- Repeat until $G(x')$ is acyclic.

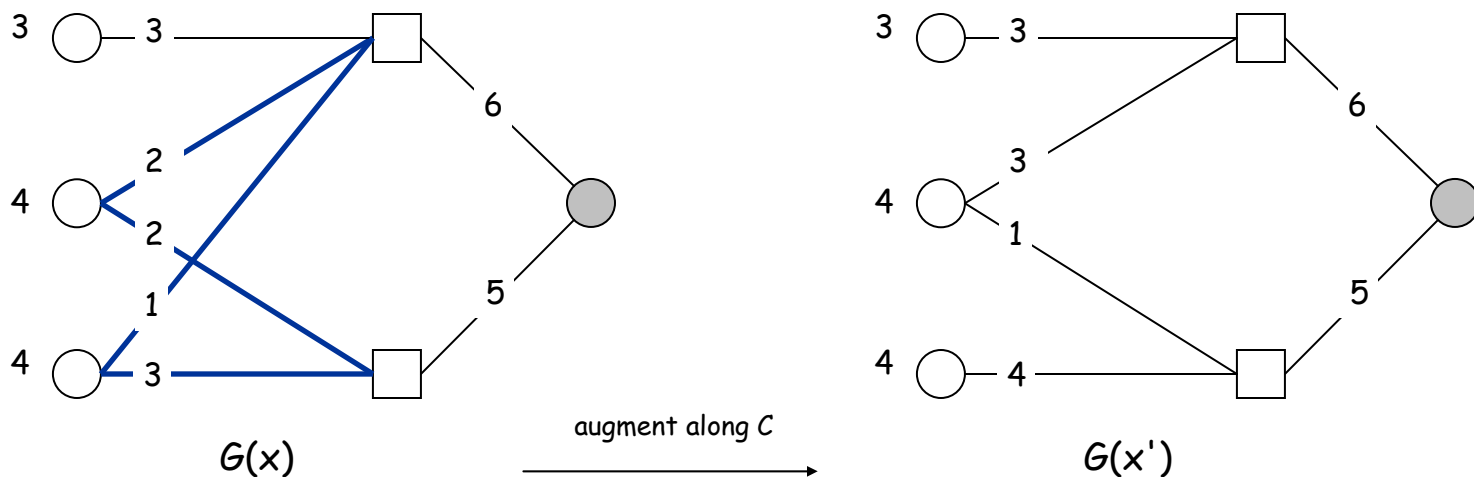

Conclusions

Running time. The bottleneck operation in our 2-approximation is solving one LP with $mn + 1$ variables.

Remark. Can solve LP using flow techniques on a graph with $m+n+1$ nodes: given L , find feasible flow if it exists. Binary search to find L^* .

Extensions: unrelated parallel machines. [Lenstra-Shmoys-Tardos 1990]

- Job j takes t_{ij} time if processed on machine i .
- 2-approximation algorithm via LP rounding.
- No $3/2$ -approximation algorithm unless $P = NP$.

11.8 Knapsack Problem

Polynomial Time Approximation Scheme

PTAS. $(1 + \varepsilon)$ -approximation algorithm for any constant $\varepsilon > 0$.

- Load balancing. [Hochbaum-Shmoys 1987]
- Euclidean TSP. [Arora 1996]

Consequence. PTAS produces arbitrarily high quality solution, but trades off accuracy for time.

This section. PTAS for knapsack problem via rounding and scaling.

Knapsack Problem

Knapsack problem.

- Given n objects and a "knapsack."
- Item i has value $v_i > 0$ and weighs $w_i > 0$. ← we'll assume $w_i \leq W$
- Knapsack can carry weight up to W .
- Goal: fill knapsack so as to maximize total value.

Ex: { 3, 4 } has value 40.

$$W = 11$$

Item	Value	Weight
1	1	1
2	6	2
3	18	5
4	22	6
5	28	7

Knapsack is NP-Complete

KNAPSACK: Given a finite set X , nonnegative weights w_i , nonnegative values v_i , a weight limit W , and a target value V , is there a subset $S \subseteq X$ such that:

$$\begin{aligned}\sum_{i \in S} w_i &\leq W \\ \sum_{i \in S} v_i &\geq V\end{aligned}$$

SUBSET-SUM: Given a finite set X , nonnegative values u_i , and an integer U , is there a subset $S \subseteq X$ whose elements sum to exactly U ?

Claim. SUBSET-SUM \leq_p KNAPSACK.

Pf. Given instance (u_1, \dots, u_n, U) of SUBSET-SUM, create KNAPSACK instance:

$$\begin{aligned}v_i = w_i = u_i & \quad \sum_{i \in S} u_i \leq U \\ V = W = U & \quad \sum_{i \in S} u_i \geq U\end{aligned}$$

Knapsack Problem: Dynamic Programming 1

Def. $OPT(i, w)$ = max value subset of items $1, \dots, i$ with weight limit w .

- Case 1: OPT does not select item i .
 - OPT selects best of $1, \dots, i-1$ using up to weight limit w
- Case 2: OPT selects item i .
 - new weight limit = $w - w_i$
 - OPT selects best of $1, \dots, i-1$ using up to weight limit $w - w_i$

$$OPT(i, w) = \begin{cases} 0 & \text{if } i = 0 \\ OPT(i-1, w) & \text{if } w_i > w \\ \max\{OPT(i-1, w), v_i + OPT(i-1, w - w_i)\} & \text{otherwise} \end{cases}$$

Running time. $O(nW)$.

- W = weight limit.
- **Not polynomial** in input size!

Knapsack Problem: Dynamic Programming II

Def. $OPT(i, v)$ = min weight subset of items 1, ..., i that yields value **exactly** v.

- Case 1: OPT does not select item i.
 - OPT selects best of 1, ..., i-1 that achieves exactly value v
- Case 2: OPT selects item i.
 - consumes weight w_i , new value needed = $v - v_i$
 - OPT selects best of 1, ..., i-1 that achieves exactly value v

$$OPT(i, v) = \begin{cases} 0 & \text{if } v = 0 \\ \infty & \text{if } i = 0, v > 0 \\ OPT(i-1, v) & \text{if } v_i > v \\ \min\{OPT(i-1, v), w_i + OPT(i-1, v - v_i)\} & \text{otherwise} \end{cases}$$

Running time. $O(n V^*) = O(n^2 v_{\max})$.

- V^* = optimal value = maximum v such that $OPT(n, v) \leq W$.
- **Not polynomial** in input size!

Knapsack: FPTAS

Intuition for approximation algorithm.

- Round all values up to lie in smaller range.
- Run dynamic programming algorithm on rounded instance.
- Return optimal items in rounded instance.

Item	Value	Weight
1	134,221	1
2	656,342	2
3	1,810,013	5
4	22,217,800	6
5	28,343,199	7

$W = 11$

original instance



Item	Value	Weight
1	2	1
2	7	2
3	19	5
4	23	6
5	29	7

$W = 11$

rounded instance

Knapsack: FPTAS

Knapsack FPTAS. Round up all values: $\bar{v}_i = \left\lceil \frac{v_i}{\theta} \right\rceil$, $\hat{v}_i = \left\lfloor \frac{v_i}{\theta} \right\rfloor$

- v_{\max} = largest value in original instance
- ϵ = precision parameter
- θ = scaling factor = $\epsilon v_{\max} / n$

Observation. Optimal solution to problems with \bar{v} or \hat{v} are equivalent.

Intuition. \bar{v} close to v so optimal solution using \bar{v} is nearly optimal;
 \hat{v} small and integral so dynamic programming algorithm is fast.

Running time. $O(n^3 / \epsilon)$.

- Dynamic program II running time is $O(n^2 \hat{v}_{\max})$, where

$$\hat{v}_{\max} = \left\lfloor \frac{v_{\max}}{\theta} \right\rfloor = \left\lfloor \frac{n}{\epsilon} \right\rfloor$$

Knapsack: FPTAS

Knapsack FPTAS. Round up all values: $\bar{v}_i = \left\lceil \frac{v_i}{\theta} \right\rceil \theta$

Theorem. If S is solution found by our algorithm and S^* is any other feasible solution then $(1+\epsilon) \sum_{i \in S} v_i \geq \sum_{i \in S^*} v_i$

Pf. Let S^* be any feasible solution satisfying weight constraint.

$$\begin{aligned} \sum_{i \in S^*} v_i &\leq \sum_{i \in S^*} \bar{v}_i \\ &\leq \sum_{i \in S} \bar{v}_i \\ &\leq \sum_{i \in S} (v_i + \theta) \\ &\leq \sum_{i \in S} v_i + n\theta \\ &\leq (1+\epsilon) \sum_{i \in S} v_i \end{aligned}$$

always round up

solve rounded instance optimally

never round up by more than θ

$|S| \leq n$

DP alg can take v_{\max}
 \downarrow
 $n\theta = \epsilon v_{\max}, v_{\max} \leq \sum_{i \in S} v_i$

Extra Slides

Load Balancing on 2 Machines

Claim. Load balancing is hard even if only 2 machines.

Pf. NUMBER-PARTITIONING \leq_p LOAD-BALANCE.

NP-complete by Exercise 8.26

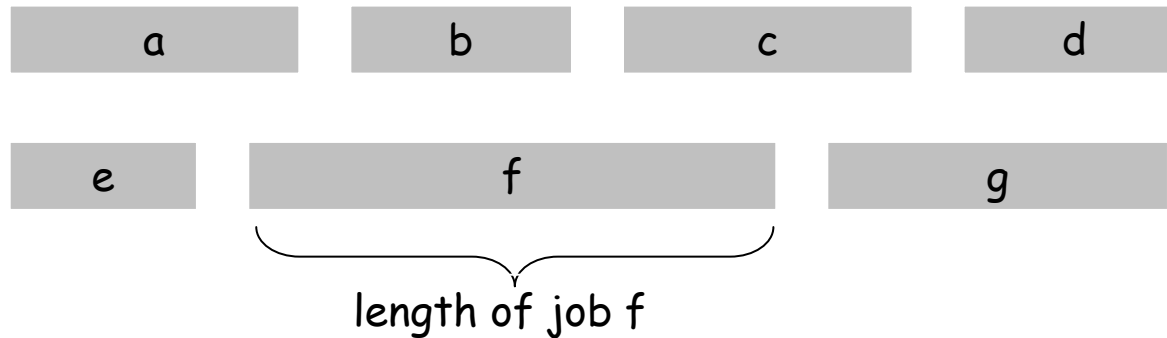

Center Selection: Hardness of Approximation

Theorem. Unless $P = NP$, there is no ρ -approximation algorithm for metric k -center problem for any $\rho < 2$.

Pf. We show how we could use a $(2 - \epsilon)$ approximation algorithm for k -center to solve DOMINATING-SET in poly-time.

- Let $G = (V, E)$, k be an instance of DOMINATING-SET. ← see Exercise 8.29
- Construct instance G' of k -center with sites V and distances
 - $d(u, v) = 2$ if $(u, v) \in E$
 - $d(u, v) = 1$ if $(u, v) \notin E$
- Note that G' satisfies the triangle inequality.
- Claim: G has dominating set of size k iff there exists k centers C^* with $r(C^*) = 1$.
- Thus, if G has a dominating set of size k , a $(2 - \epsilon)$ -approximation algorithm on G' must find a solution C^* with $r(C^*) = 1$ since it cannot use any edge of distance 2.